

**COMPANY**  
**CATALOGUE**



**Guangzhou MIJIA Aerosol Can**

[www.mgaerosolcan.com](http://www.mgaerosolcan.com)

## ABOUT US

**Guangzhou MIJIA** Trading Co., Ltd., established in 2021, is the International Affairs Department of **Guangzhou Yingli** Packaging Products Co., Ltd.

Guangzhou Yingli, founded in 2010, is a professional company based in China, striving for Metal Can Packaging industry over 10 years, with OEM and ODM service.

Production equipped with advanced automatic machine, Japan FUJI printing lines and German Sudronic can-making Lines, including 15 automatic production lines for metal cans and aerosol tin cans, 20 automatic lines for top and bottom pressing. The companies promoters and the core members bring with them decades of experience in the metal can packaging field, including product research and design, production technology and process, strict quality control, pre-sale and after-sales quality assurance. All products 100% test before delivered.

Guangzhou Yingli owes its success to refined and transparent management principles gained over decades of experience, a commitment to reinvesting year over year and forging long term relationships with great business partners.

Guangzhou Yingli ensures quality for its clients and also envisions to look at its products from the end consumer point of view to bring top end packaging solutions.

## PRODUCTS

Aerosol Tin Can | Aluminum Can  
Aerosol Valve and Actuator | Plastic Cap

Shoulder Height: mm

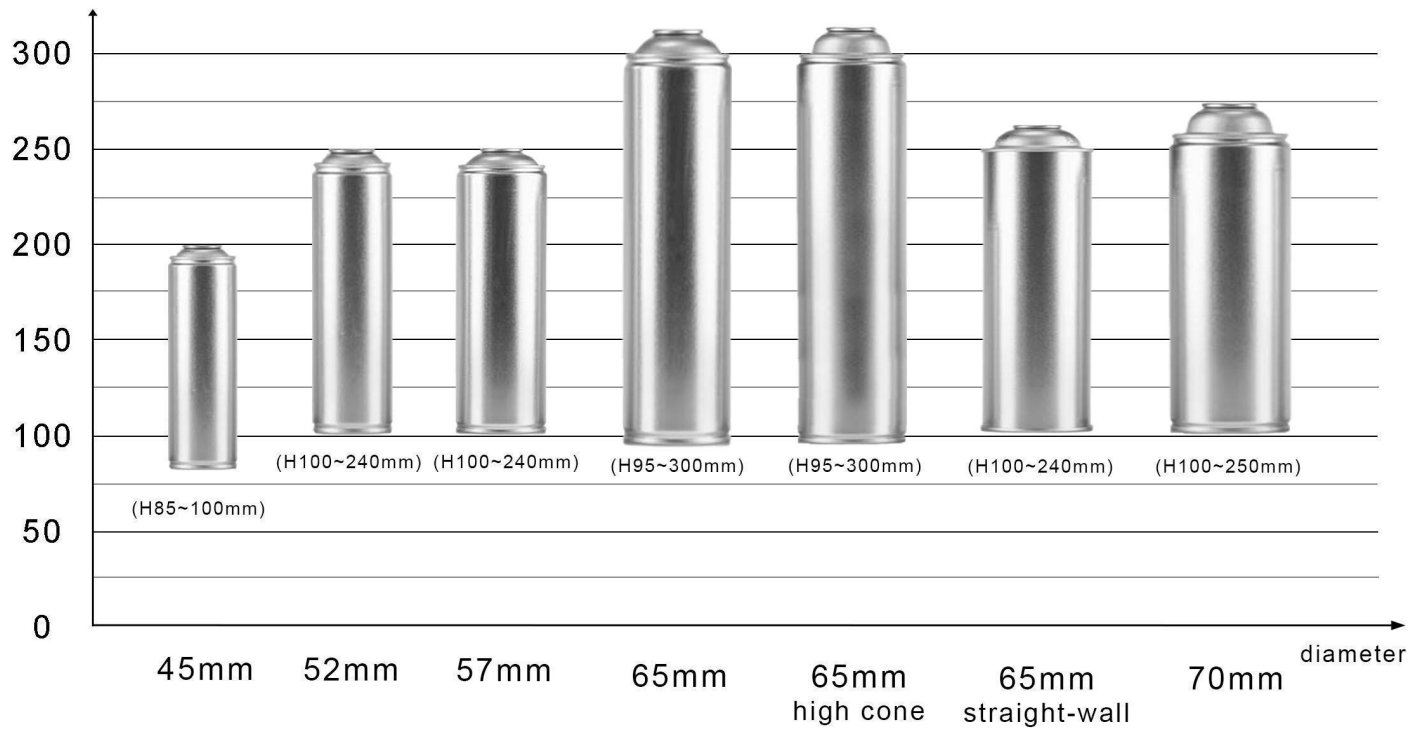



## Diam. 45mm

## General Purpose



**45mm diameter** is a small type of aerosol tin can which is generally used for celebratory spray products, personal care products, car care aerosol products, such as snow spray, snow string, deodorant spray, lubricant spray, shoe polish spray etc.



Type	Necked-in
Color	silver / white coated / CMYK or Pantone
Height	85-100mm (not include top cone height)
Tin Thickness	Body 0.18mm; Top&Bottom 0.25mm
Pressure	deform $\geq 12.00$ Bar; burst $\geq 14.00$ Bar
Inside Lacquer	Acceptable

## General Purpose

## Diam. 52mm

**52mm diameter** is a widely used aerosol can sizes on the market. Mainly applied in personal can spray and car care spray product, including hair spray, electroplating paint spray, refill butane gas, air freshener spray, deodorant spray, snow spray etc.



Type	Necked-in
Color	silver / white coated / CMYK or Pantone
Height	100-240mm (not include top cone height)
Tin Thickness	Body 0.19mm; Top&Bottom 0.25/0.27mm
Pressure	deform $\geq 12.50$ Bar; burst $\geq 14.00$ Bar
Inside Lacquer	Acceptable

## Diam. 57mm

## General Purpose



**57mm diameter** is a special type of aerosol tin can which is the middle size between 52 and 65mm, and it is more better to balance capacity and size. Extensive use for household spray product, such as insecticide spray, air freshener, handling spray paint, etc.



Type	Necked-in
Color	silver / white coated / CMYK or Pantone
Height	100-240mm (not include top cone height)
Tin Thickness	Body 0.18mm; Top&Bottom 0.25mm
Pressure	deform $\geq 12.00$ Bar; burst $\geq 14.00$ Bar
Inside Lacquer	Acceptable



## Diam. 65mm

## General Purpose



**65mm diameter** as the most widely used and popular aerosol can size on the market. It's mainly applies to car care aerosol industries, such as lubricant spray, engine oil spray, car care cleaner spray, spray paint for car, mold release spray and auto glue cleaner etc.

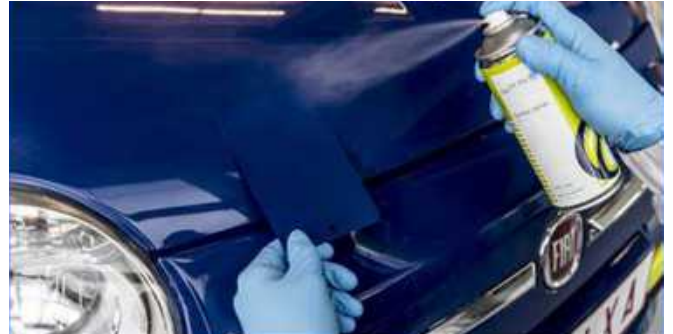

Type	Necked-in
Color	silver / white coated / CMYK or Pantone
Height	95-300mm (not include top cone height)
Tin Thickness	Body 0.19mm; Top&Bottom 0.32mm
Pressure	deform $\geq 12.00$ Bar; burst $\geq 14.00$ Bar
Inside Lacquer	Acceptable

## General Purpose

## Diam. 65mm

**65mm diameter straight-wall** is a type of aerosol tin can which is almost extensively for butane gas can, camping gas can or portable gas can for gas stove with the standard size 65\*158mm on the market. In addition, some car care products will also be packaged with this type of cans.



Type	Straight-wall
Color	silver / white coated / CMYK or Pantone
Height	100-240mm (not include top cone height)
Tin Thickness	Body 0.19mm; Top&Bottom 0.35mm
Pressure	deform $\geq 13.50$ Bar; burst $\geq 15.50$ Bar
Inside Lacquer	Acceptable

## General Purpose

## Diam. 70mm



**70mm diameter** can meet some requirements for high-capacity packaging products. Usually packaged for multifunctional PU foam and parts cleaning agent, which also mostly used for packaging some automotive care spray products.



Type	Necked-in
Color	silver / white coated / CMYK or Pantone
Height	100-250mm (not include top cone height)
Tin Thickness	Body 0.20mm; Top&Bottom 0.32/0.35mm
Pressure	deform $\geq 13.50$ Bar; burst $\geq 15.00$ Bar
Inside Lacquer	Acceptable

1 Inch Valve (φ25.40mm)



Plain Tinplate Valve



Clear Lacquer Valve



Golden Lacquer Valve



Clear Lacquer Aluminum Valve



Golden Lacquer Aluminum Valve



360 Degree Valve(Tinplate/Alu.)



Spray Paint



Moisturing Valve



Body Spray



Mould Release



Spray Glue



Extinguisher Valve



Epilate Spray

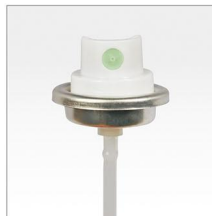

Spray Wax



Powder Valve



Party String Valve



Carburetor Contact Valve



Mousse Valve



Multi Purpose Foam



Body Deodorant



Hair Spray Air Freshener



Snow Spray Insecticide Spray



Anti-rust Valve



Air Horn Valve Oxygen Valve Ink Valve

## Butane Gas Valve

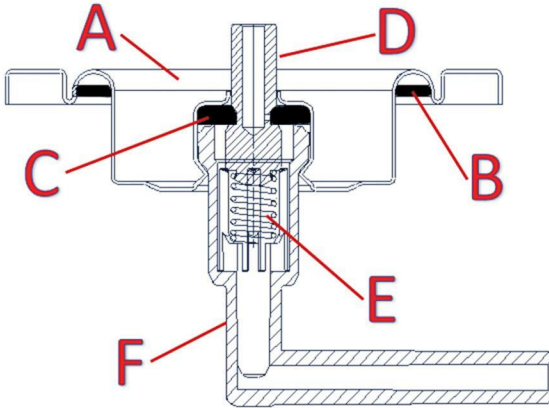

A. Mounting Cup (Material: Tinplate)

B. Outer Gasket (Material: Buna)

C. Inner Gasket (Material: Buna)

D. Stem (Material: Zinc Alloy)

E. Spring (Material: Stainless Steel)

F. Housing (Material: POM Natural)



## Acuator Series

Picture	Insert Color/Code	Insert Orifice	Insert Type	Application
	blue 2-DI black 2-EI	0.33mm	concave	body spray, hair oil
	black 2-DL/EL	0.41mm	concave	body spray, mould release
	yellow 2-DP black 2-EP	0.46mm	plain	hair spray, air freshener, body spray
	red 2-DS black 2-ES	0.64mm	plain	cleaner, multi-purpose foam
	orange 2-DB black 2-EB	0.84mm	plain	cleaner, spray paint







Acutator Series

Picture	Insert Color/Code	Insert Orifice	Insert Type	Application
	red 2-DH black 2-EH	1.00mm	concave	cleaner, spray paint
	yellow 2-EP-2	0.46mm	concave	body deodorant, hair oil
	black 2-FF	0.46mm	plain	body deodorant, hair oil
	light blue 2-XR	0.51mm	plain (none MBU)	powder spray, spray paint
	green 2-ZK	0.51mm	L type	spray wax
	natural 2-VO	0.25mm	plain	moisturing valve
	green 2-YL red-2YL white-2-NL	0.51mm 0.64mm	L type	spray paint
	green 2-ML red-2ML white-2-NL	0.51mm 0.64mm	L type	spray paint
	blue 2-UN black-2UL yellow-2-UP red-2-US orange-2-UB red-2-UH	0.33mm 0.41mm 0.46mm 0.64mm 0.84mm 1.00mm	concave plain	mould release, body spray
	black 2-DC	0.50mm tube 2.15mm	plain	cleaner





Acutator Series

Picture	Insert Color/Code	Insert Orifice	Insert Type	Application
	blue 2-RB	1.00mm tube 2.15mm	L type	cleaner
	blue 2-QB gold blue 2-QB white	1.00mm tube 2.15mm	L type	cleaner
	2-KB	1.00mm tube 2.15mm	/	cleaner, lubricant, anti-rust, carburetor cleaner
	2-KM 2-KF	1.00mm 2.50mm	/	rubberized undercoating, spray glue, air conditioner, cleaning agent, cleaner
	2-KE 2-KC	0.84mm 1.00mm	/	insecticide, fire extinguisher
	2-AC	0.84mm	/	fire extinguisher, oil based engine degreasers
	blue 2-SI	0.33mm	concave	body spray
	black 2-SL	0.41mm	concave	mould release, shaving foam
	yellow 2-SP	0.46mm	plain	car remover, spray wax
	red 2-SS	0.64mm	plain	multi-purpose foam. cleaner
	orange 2-SB	0.84mm	plain	cleaner

### Acutator Series

Picture	Insert Color/Code	Insert Orifice	Insert Type	Application
	red 2-SH	1.00mm	plain	cleaner
	2-AD	0.84mm	/	cleaner
	2-AH	1.00mm	/	party string spray
	2-CB 2-CA no spray tube	1.00mm	/	cleaner, lubricant, anti-rust, carburetor cleaner

### Trigger Gun Series

Picture	Insert Color/Code	Insert Orifice	Insert Type	Application
	red 6-PWS orange 6-PWB red 6-PWH	0.64mm 0.84mm 1.00mm	plain	cleaner
	6-PKC red tube 6-PKE natural tube 6-PKB red tube	0.64mm 0.84mm 1.00mm	/	cleaner
	6-PKD	5.00mm Natural Tube	/	cleaner
	6-PCF	1.50mm	/	snow spray, cleaner





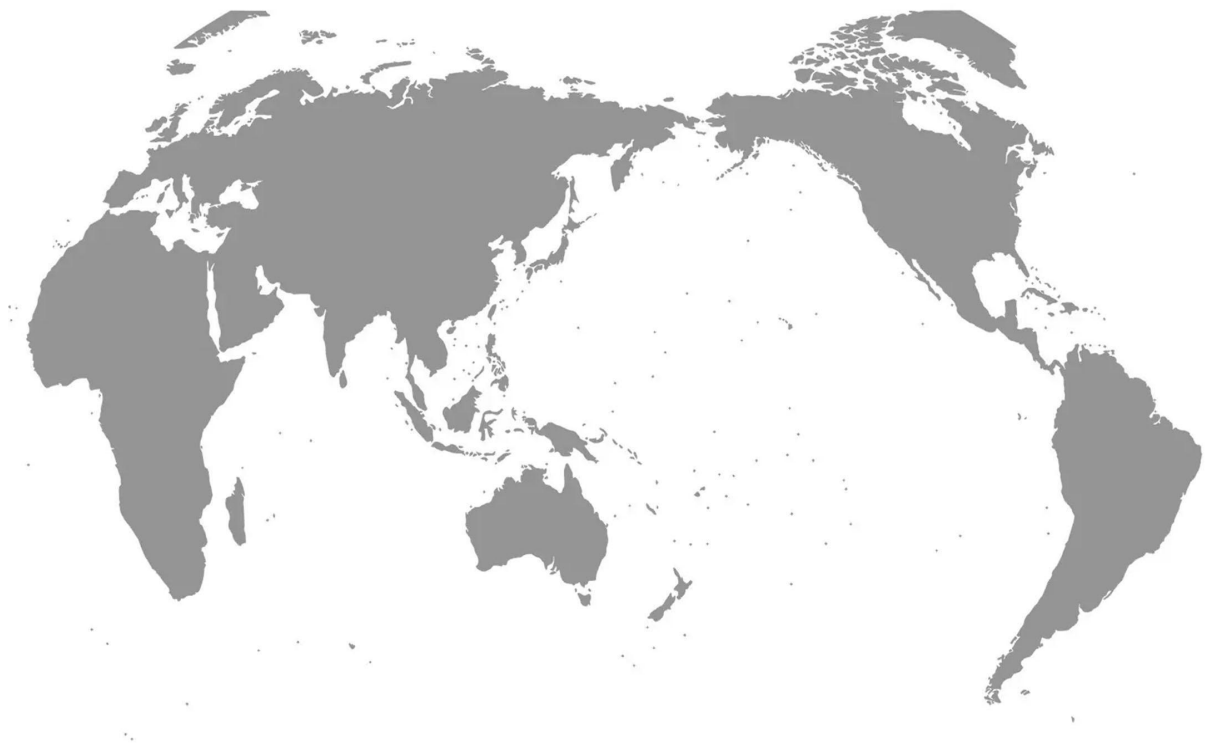

ISO9001:2015 company

**Guangzhou Yingli Packaging Products Co., Ltd.**

**Guangzhou MIJIA Trading Co., Ltd.**

P.O. box 511370 Guangzhou China

🌐 [www.mgaerosolcan.com](http://www.mgaerosolcan.com)    ✉ [info@mgaerosolcan.com](mailto:info@mgaerosolcan.com)

Empty Metal Can, Empty Aerosol Tin Can, Empty Aluminum Can, Aerosol Valve & Atuator, Plastic Cap

